

FOR: \_\_\_\_\_

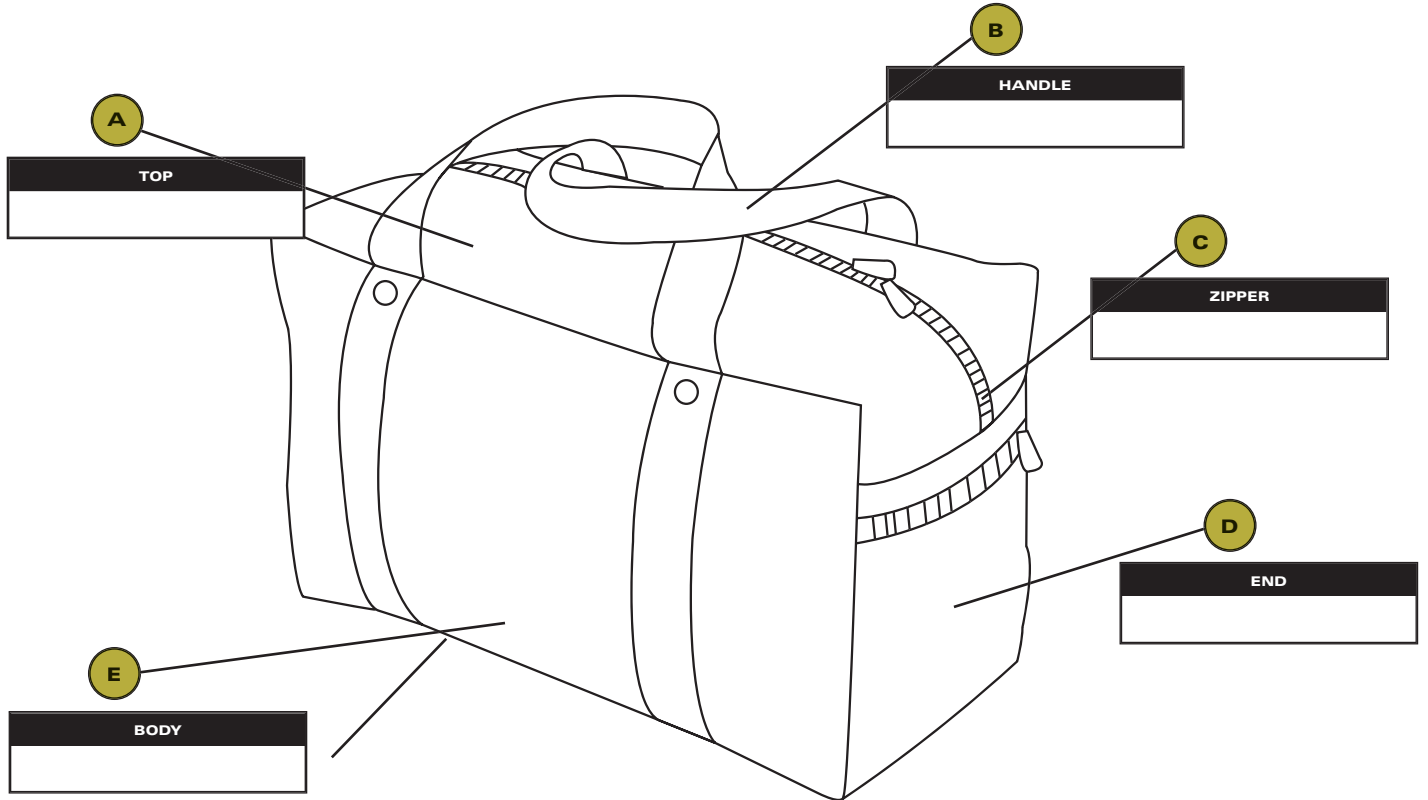



































DATE: \_\_\_\_\_



## DIRECTIONS

Fill in the color of your choice (using the chart at right) for each of the parts or panels of the bag specified above. Fax this sheet, along with your order form to 320.654.1529.

## AVAILABLE COLORS

FABRIC		WEBBING	
 BURGUNDY/MAROON	 VEGAS GOLD	 SILVER	 WHITE
 CARDINAL RED	 PINK	 SPORT GOLD	 BURGUNDY/MAROON
 SILVER	 SPORT GOLD	 ORANGE	 ROYAL BLUE
 KELLY GREEN	 ROYAL BLUE	 KELLY GREEN	 PURPLE
 WHITE	 FOREST GREEN	 BLACK	 CARDINAL RED
 ORANGE	 BLACK	 BROWN	 VEGAS GOLD
 NAVY	 DARK BROWN	 RED	 FOREST GREEN
 PURPLE		 PINK	 COLUMBIA BLUE
 RED		 NAVY	
ZIPPER		MESH VENTS	
 BLACK	 WHITE	 BLACK	 WHITE